

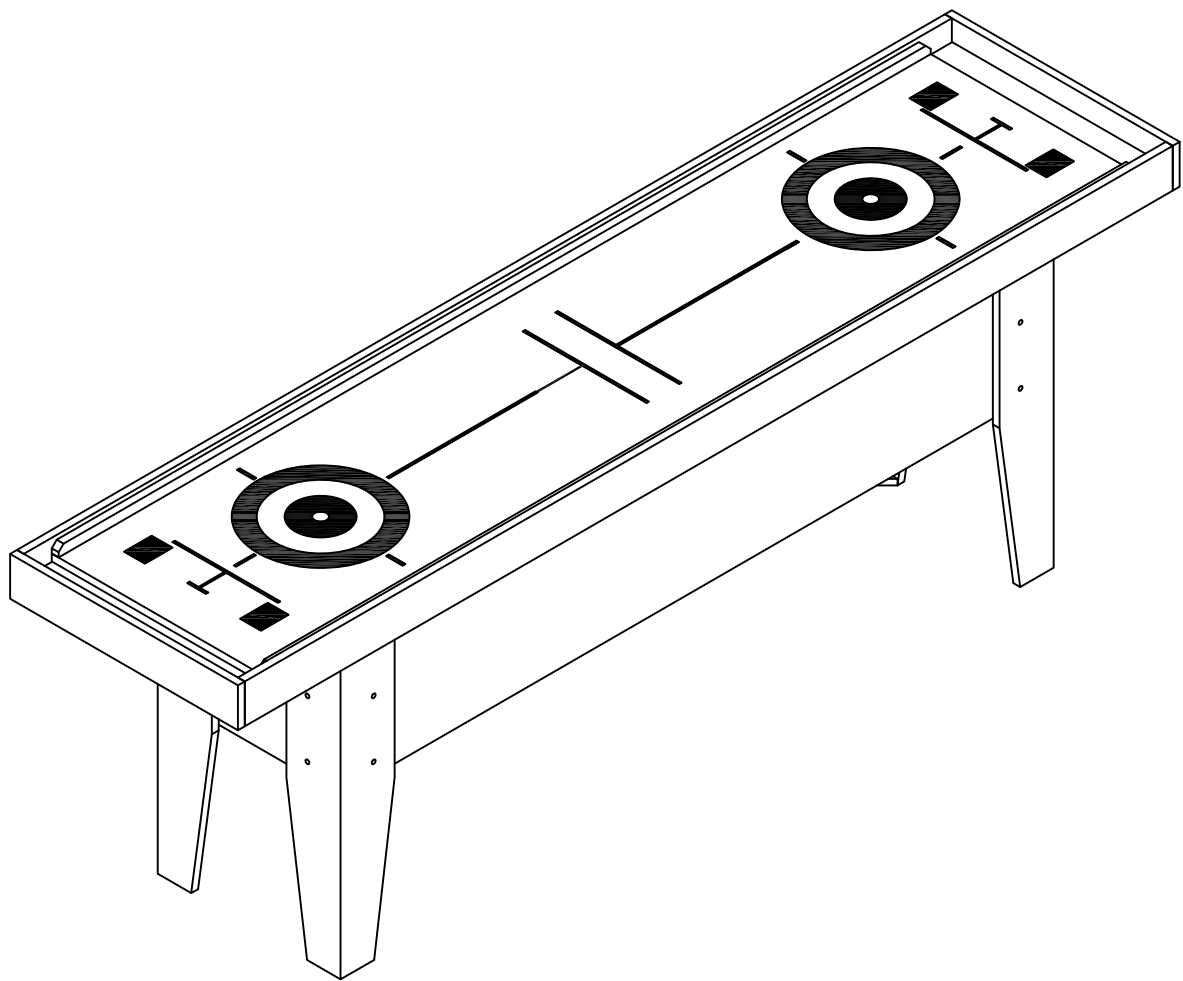









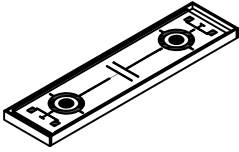

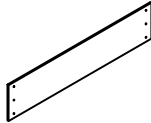

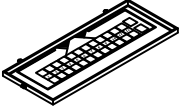
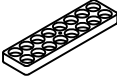

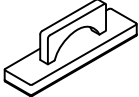



# ASSEMBLY INSTRUCTIONS

(Original Table)



# PARTS LIST

(ASSEMBLY PARTS)

<p><b>#1</b></p>  <p>Table Body 1 set</p>	<p><b>#2</b></p>  <p>Leg 4 pieces</p>	<p><b>#3</b></p>  <p>Side Panel 4 pieces</p>	<p><b>#4</b></p>  <p>End Panel 4 pieces</p>
<p><b>#5</b></p>  <p>Score Board 1 set</p>	<p><b>#6</b></p>  <p>Wood Holder 1 piece</p>	<p><b>#7</b></p>  <p>Pebble 1 piece</p>	<p><b>#8</b></p>  <p>Wax 1 piece</p>
<p><b>#9</b></p>  <p>Wooden Brush 1 piece</p>	<p><b>#10</b></p>  <p>Eraser 1 piece</p>	<p><b>#11</b></p>  <p>Pen 1 piece</p>	<p><b>#12</b></p>  <p>Handle 1 piece</p>
<p><b>#13</b></p>  <p>Stones Colour #1 8 pieces</p>	<p><b>#14</b></p>  <p>Stones Colour #2 8 pieces</p>	<p><b>#15</b></p>  <p>Leg Leveler 4 pieces</p>	<p><b>#16</b></p>  <p>Allen Tool 1 piece</p>
<p><b>#17</b></p>  <p>M8X30MM Bolt 24 pieces</p>	<p><b>#18</b></p>  <p>19MM Washer 24 pieces</p>	<p><b>#19</b></p>  <p>4x32mm Screw 2 pieces</p>	<p><b>#20</b></p>  <p>Plastic Anchor 2 pieces</p>
<p><b>#21</b></p>  <p>4x32mm Bolt 1 piece</p>	<p><b>#22</b></p>  <p>"L" Bracket 10 pieces</p>	<p><b>#23</b></p>  <p>4x15mm Screw 40 pieces</p>	

# STEP 1

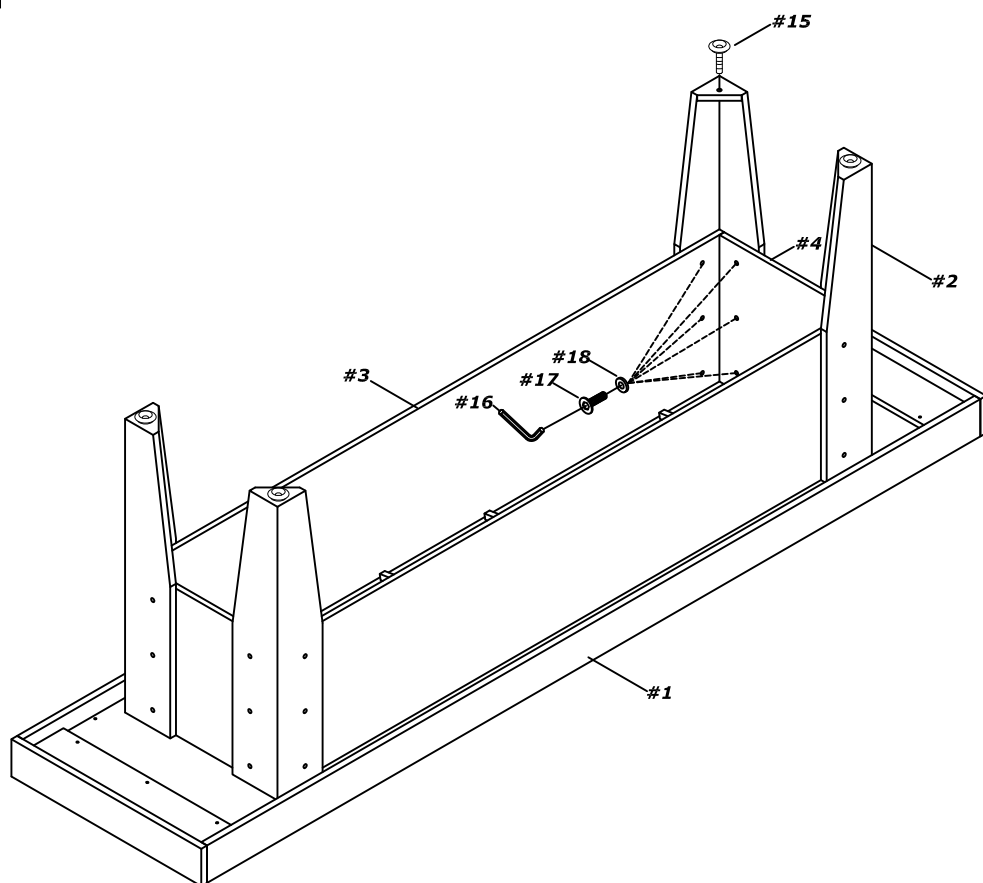

# STEP 2

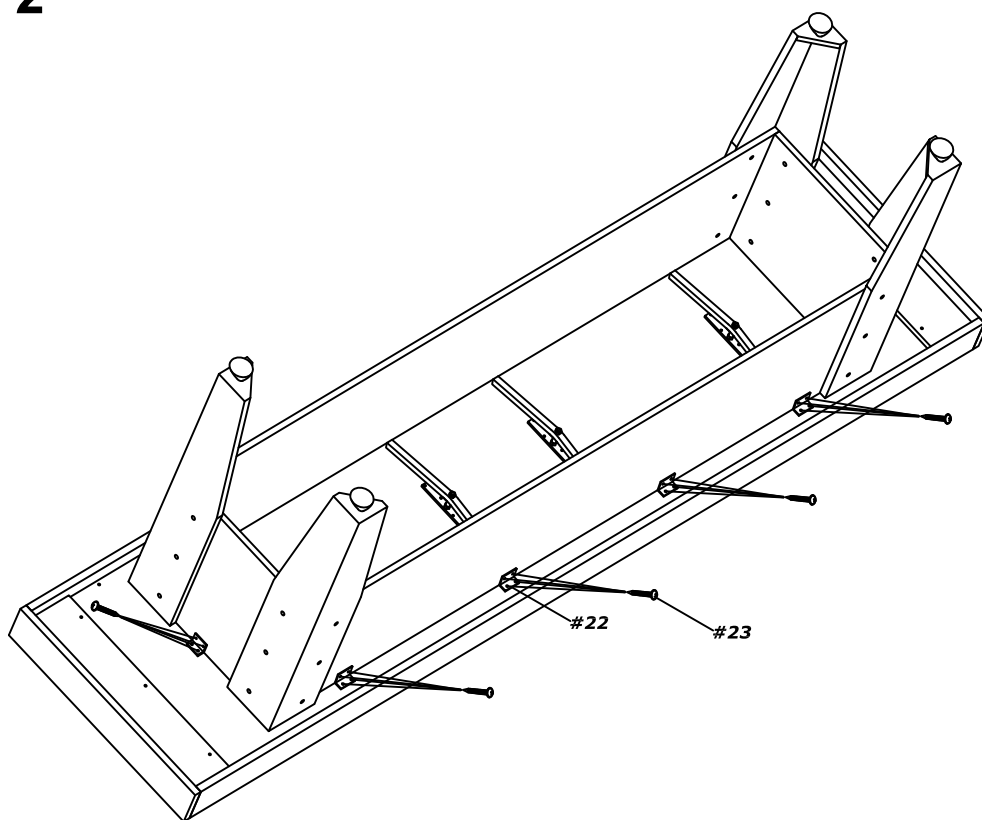

# STEP 3

