

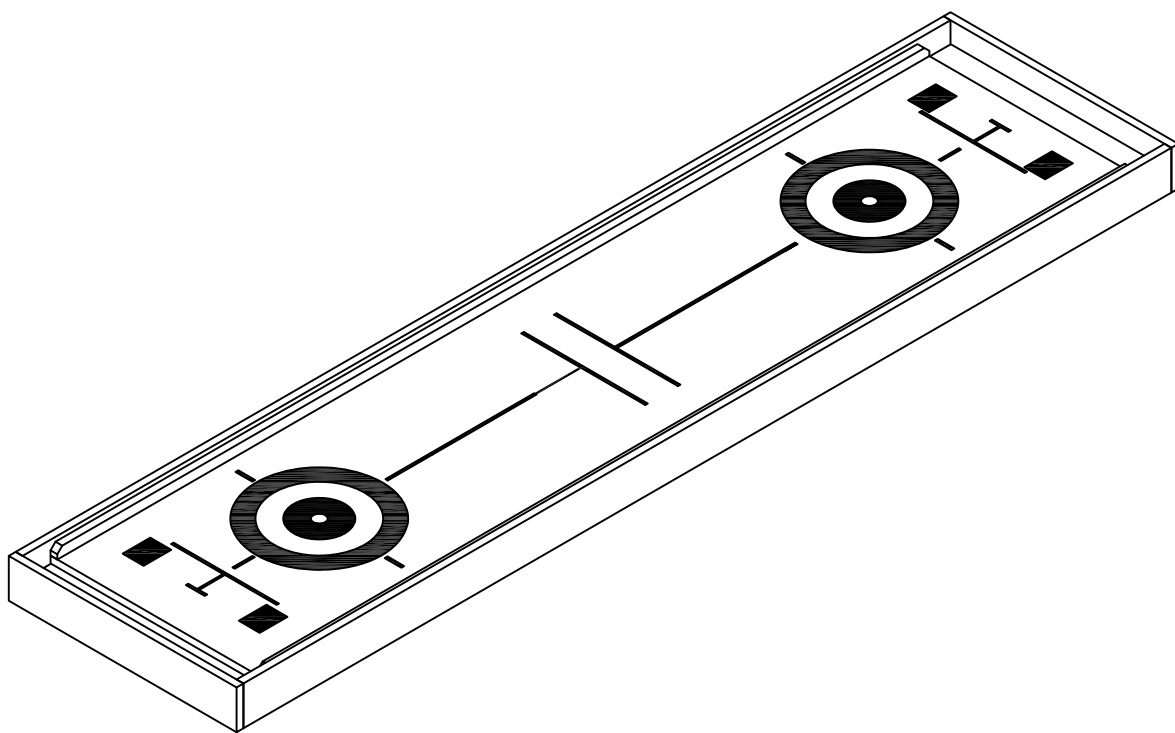









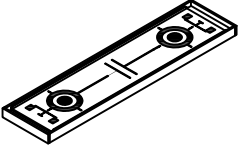
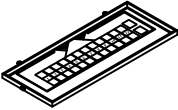
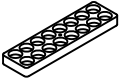

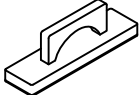
ASSEMBLY INSTRUCTIONS

(Premiere Conversion Top)



PARTS LIST

(ASSEMBLY PARTS)

<p>#1</p>  <p>Table Body 1 set</p>	<p>#2</p>  <p>Score Board 1 set</p>	<p>#3</p>  <p>Wood Holder 1 piece</p>	<p>#4</p>  <p>Pebble 1 piece</p>
<p>#5</p>  <p>Wax 1 piece</p>	<p>#6</p>  <p>Wooden Brush 1 piece</p>	<p>#7</p>  <p>Eraser 1 piece</p>	<p>#8</p>  <p>Pen 1 piece</p>
<p>#9</p>  <p>Handle 1 piece</p>	<p>#10</p>  <p>Stones Colour #1 8 pieces</p>	<p>#11</p>  <p>Stones Colour #2 8 pieces</p>	<p>#12</p>  <p>4x32mm Screw 2 pieces</p>
<p>#13</p>  <p>Plastic Anchor 2 pieces</p>	<p>#14</p>  <p>4x32mm Bolt 1 piece</p>	<p>#15 PRE-ASSEMBLED</p>  <p>"L" Bracket 4 pieces</p>	

STEP 1

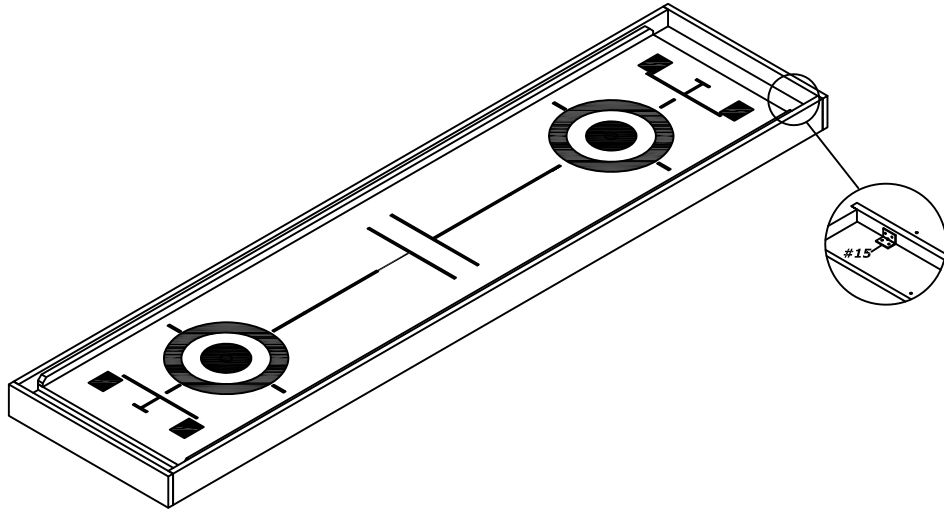

STEP 2

